

# POWER RELAY

## 1 POLE - 20/25/30A - Heavy power control

### VF Series

#### ■ FEATURES

- UL, CSA, VDE recognized TV-15 rated
  - 1 form A contact (SPST-NO)
  - Heavy duty 20 to 30A small power relay
  - High inrush current and high surge voltage
    - Inrush current 65A
    - Surge strength 10,000V
  - Printed circuit coil terminals type available
  - Small package meets high density mounting requirement
  - Flux proof sealing, RTII
  - RoHS Compliant
- Please see page 7 for more information



#### ■ PARTNUMBER INFORMATION

[Example]      VF      B - 6      H      U  
                   (a)      (b) (\*) (c)      (d)      (e)

(a)	Relay type	VF	: VF Series
(b)	Terminal	Nil B D P	: Top -- All tab-terminal : Top -- Tab terminal (contacts) Bottom -- PCB terminal (coil and movable contact) : Top -- Tab terminal (coil) Screw tight terminal (contacts) : Top -- Screw tight terminal (contacts) Bottom -- PCB terminal (coil and movable contact)
(c)	Coil rated voltage	6	: 3...60VDC Coil rating table at page 3
(d)	Contact rating	H M L	: 30A (applicable for D.P.) : 25A : 20A
(e)	Approvals	U	: UL, CSA, VDE rating acquired

Note: Actual marking omits hyphen (-) of (\*)

# VF SERIES

## ■ SPECIFICATION

Item			30A type	25A type	20A type
			VFD, VFP - ( ) H	VF ( ) - ( ) M	VF ( ) - ( ) L
Contact Data	Configuration		1 form A (SPST-NO)		
	Construction		Single		
	Material		Silver alloy (AgSnO <sub>2</sub> ; AgSnOInO)		
	Resistance (initial)		Max. 30mOhm at 1A, 6VDC		
	Contact rating	Resistive	30A, 250VAC	25A, 250VAC	20A, 250VAC
		Motor	2HP, 250VAC	1.5HP, 250VAC	1HP, 250VAC
	Max. carrying current		30A	25A	20A
	Max. switching voltage		250VAC		
	Max. switching power		7,500VA	6,250VA	5,000VA
	Max. switching current		30A	25A	20A
Min. switching load *		1A, 10V			
Life	Mechanical		Min. 5 x 10 <sup>6</sup> operations		
	Electrical (at contact rating)	Resistive load	Min. 100 x 10 <sup>3</sup> operations		
		Motor load	Min. 200 x 10 <sup>3</sup> operations		
Coil Data	Rated Power (at 20 ° C)		1,200 to 1,250mW		
	Operate Power (at 20 ° C)		590 to 620mW		
	Operating temperature range		-30 to +65 °C (no frost)		
Timing Data	Operate (at nominal voltage)		Max. 20ms		
	Release (at nominal voltage)		Max. 5ms (without diode)		
Insulation	Resistance (Initial)		Min. 1,000MOhm at 500VDC		
	Dielectric strength	Open contacts	1,200VAC (50/60Hz) 1min.		
		Coil and contacts	4,000VAC (50/60Hz) 1min.		
Surge strength		Coil and contacts	10.000V/ 1.2 x 50µs standard wave		
Other	Vibration Resistance	Misoperation	10 to 55Hz double amplitude 1.5mm		
		Endurance	10 to 55Hz double amplitude 1.5mm		
	Shock	Misoperation	Min. 200m/s <sup>2</sup> (11 ± 1ms)		
		Endurance	Min. 1,000m/s <sup>2</sup> (6 ± 1ms)		
	Weight		Approximately 55 g		
	Sealing		Flux proof (RTII)		

\* Minimum switching loads mentioned above are reference values. Please perform the confirmation test with actual load before production since reference values may vary according to switching frequencies, environmental conditions and expected reliability levels.

# VF SERIES

## ■ COIL RATING

Coil Code	Rated Coil Voltage (VDC)	Coil Resistance +/- 10% (Ohm)	Must Operate Voltage (VDC) *	Must Release Voltage (VDC) *	Rated Power (mW)
3	3	7.5	2.1	0.3	1,200
5	5	20	3.5	0.5	1,250
6	6	30	4.2	0.6	1,200
9	9	67	6.3	0.9	
12	12	120	8.4	1.2	
18	18	270	12.6	1.8	
24	24	480	16.8	2.4	
48	48	1,920	33.6	4.8	
60	60	3,000	42.0	6.0	

Note: All values in the table are valid for 20°C and zero contact current.

\* Specified operate values are valid for pulse wave voltage.

## ■ SAFETY STANDARDS

Type	Compliance	Contact rating
UL	UL 508 873	Flammability: UL 94-V0 (plastics)
	E56140	VF - ( ) - ( ) L 20A, 250VAC (resistive)
CSA	C22.2 No. 14	1HP, 250VAC/125VAC
	LR 35579	TV-15, 120VAC VF - ( ) - ( ) M 25A, 250VAC (resistive) 1.5HP, 250VAC TV-15, 120VAC VFD, VFP - ( ) - H 30A, 250VAC (resistive) 2HP, 250VAC TV-15, 120VAC
VDE	0435	VF-(;B)-LU: 20A, 250VAC resistive: 100K 15A, 250VAC cos φ 0.7: 100K
	40017717	VF-(;B)-HU: 30A, 250VAC resistive: 100K 22.5A, 250VAC cos φ 0.7: 100K

# VF SERIES

## CHARACTERISTIC DATA

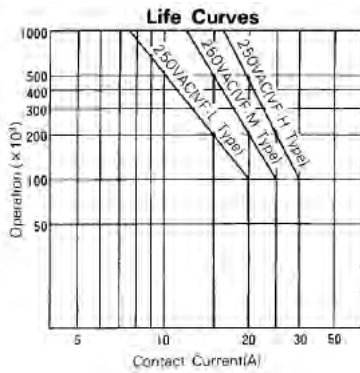
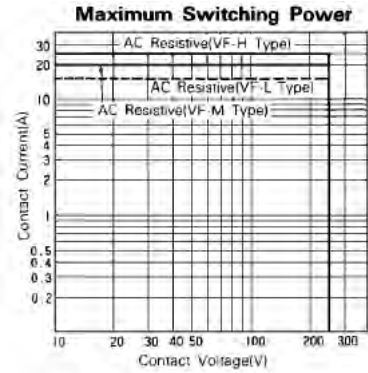
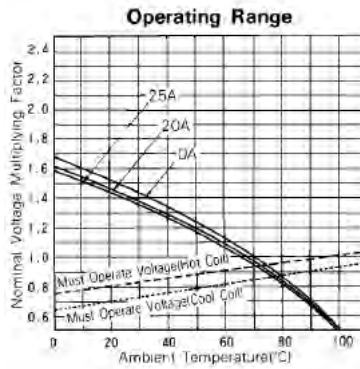
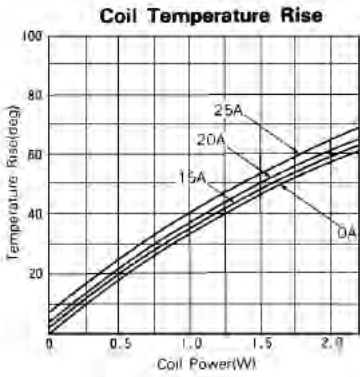

## REFERENCE DATA

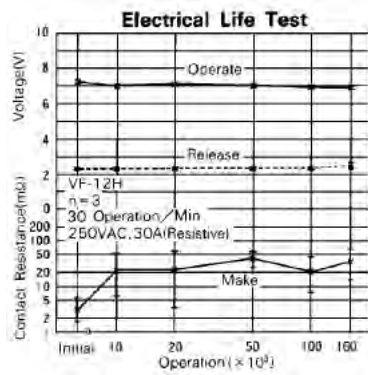
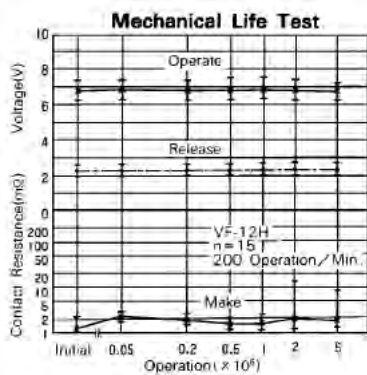
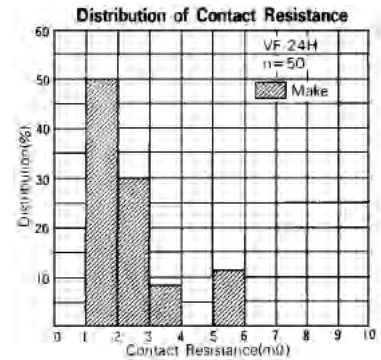
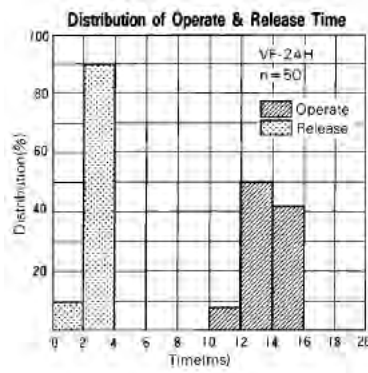
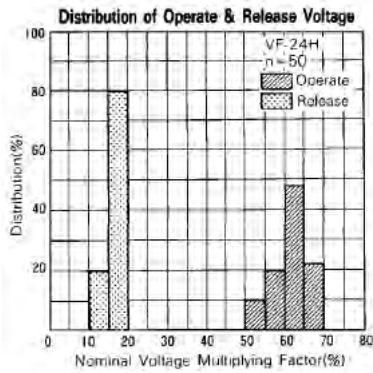

# VF SERIES

## ■ DIMENSIONS

### ● Dimensions

VF-type

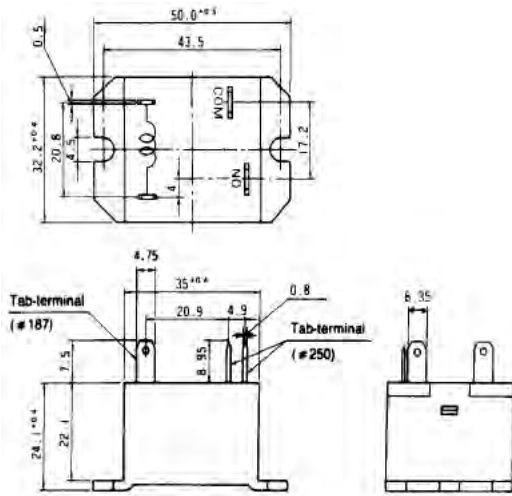

### ● Schematics (TOP VIEW)

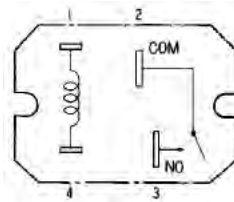

### ● PC board mounting hole layout (TOP VIEW)

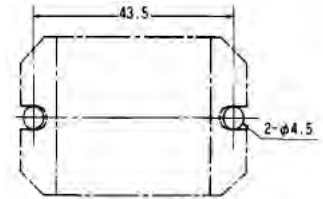

VFB-type

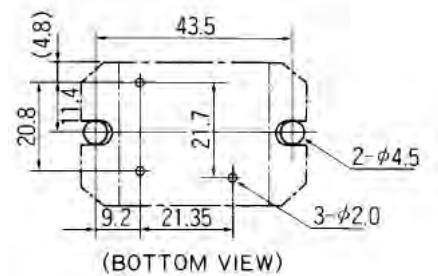
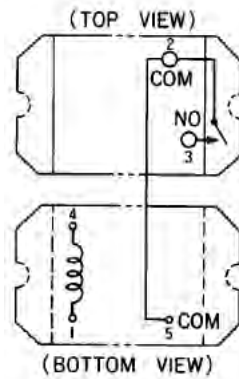
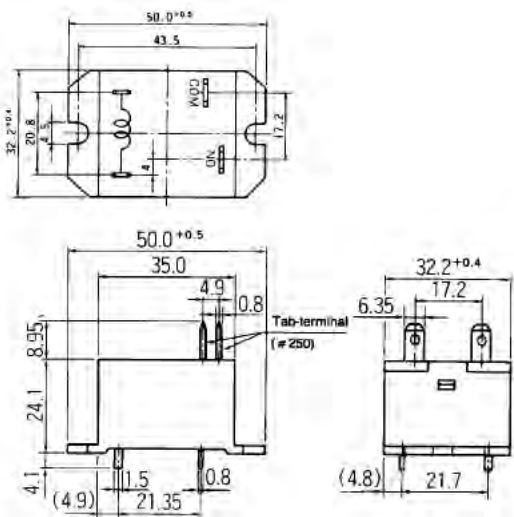

Unit: mm

# VF SERIES

## ■ DIMENSIONS

### ● Dimensions

VFD-type

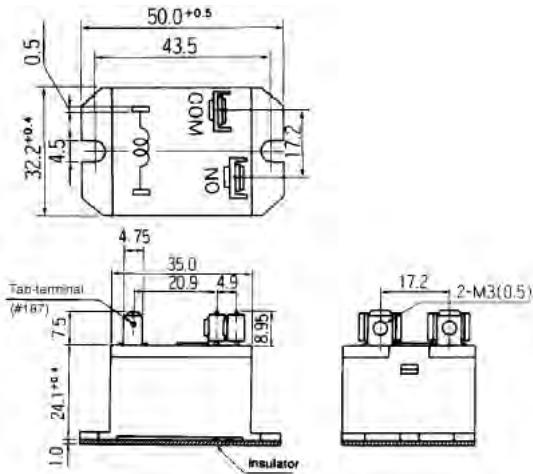

### ● Schematics (TOP VIEW)

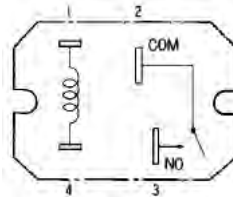

### ● PC board mounting hole layout (TOP VIEW)

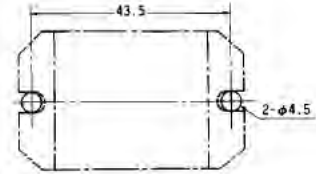

VFP-type

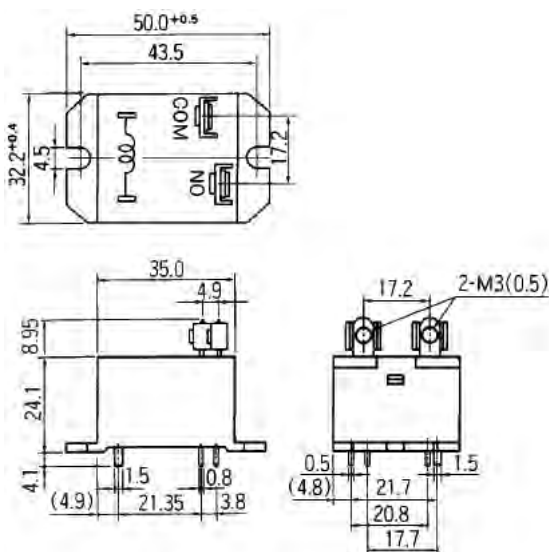

### (TOP VIEW)

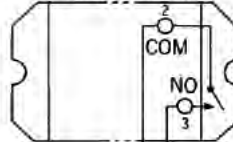

### (BOTTOM VIEW)

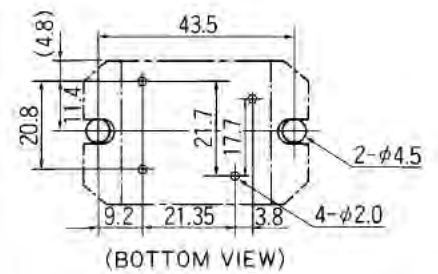
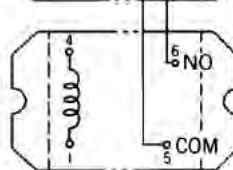

Unit: mm

## RoHS Compliance and Lead Free Information

### 1. General Information

- All signal and power relays produced by Fujitsu Components are compliant with RoHS directive 2002/95EC including amendments.
- Cadmium as used in electrical contacts is exempted from the RoHS directives on October 21st, 2005. (Amendment to Directive 2002/95/EC)
- All of our signal and power relays are lead-free. Please refer to Lead-Free Status Info for older date codes at: <http://www.fujitsu.com/us/downloads/MICRO/fcai/relays/lead-free-letter.pdf>
- Lead free solder plating on relay terminals is Sn-3.0Ag-0.5Cu, unless otherwise specified. This material has been verified to be compatible with PbSn assembly process.

### 2. Recommended Lead Free Solder Profile

- Recommended solder Sn-3.0Ag-0.5Cu.

**Flow Solder condition:**

Pre-heating: maximum 120°C  
Soldering: dip within 5 sec. at  
260°C solder bath

**Solder by Soldering Iron:**

Soldering Iron  
Temperature: maximum 360°C  
Duration: maximum 3 sec.

**We highly recommend that you confirm your actual solder conditions**

### 3. Moisture Sensitivity

- Moisture Sensitivity Level standard is not applicable to electromechanical relays, unless otherwise indicated.

### 4. Tin Whiskers

- Dipped SnAgCu solder is known as presenting a low risk to tin whisker development. No considerable length whisker was found by our in house test.

## Fujitsu Components International Headquarter Offices

### Japan

Fujitsu Component Limited  
Gotanda-Chuo Building  
3-5, Higashigotanda 2-chome, Shinagawa-ku  
Tokyo 141, Japan  
Tel: (81-3) 5449-7010  
Fax: (81-3) 5449-2626  
Email: [promothq@ft.ed.fujitsu.com](mailto:promothq@ft.ed.fujitsu.com)  
Web: [www.fcl.fujitsu.com](http://www.fcl.fujitsu.com)

### North and South America

Fujitsu Components America, Inc.  
250 E. Caribbean Drive  
Sunnyvale, CA 94089 U.S.A.  
Tel: (1-408) 745-4900  
Fax: (1-408) 745-4970  
Email: [components@us.fujitsu.com](mailto:components@us.fujitsu.com)  
Web: <http://us.fujitsu.com/components>

### Europe

Fujitsu Components Europe B.V.  
Diamantlaan 25  
2132 WV Hoofddorp  
Netherlands  
Tel: (31-23) 5560910  
Fax: (31-23) 5560950  
Email: [info@fceu.fujitsu.com](mailto:info@fceu.fujitsu.com)  
Web: [emea.fujitsu.com/components/](http://emea.fujitsu.com/components/)

### Asia Pacific

Fujitsu Components Asia Ltd.  
102E Pasir Panjang Road  
#01-01 Citilink Warehouse Complex  
Singapore 118529  
Tel: (65) 6375-8560  
Fax: (65) 6273-3021  
Email: [fcal@fcal.fujitsu.com](mailto:fcal@fcal.fujitsu.com)  
Web: <http://www.fujitsu.com/sg/services/micro/components/>

©2011 Fujitsu Components Europe B.V. All rights reserved. All trademarks or registered trademarks are the property of their respective owners.

The contents, data and information in this datasheet are provided by Fujitsu Component Ltd. as a service only to its user and only for general information purposes.

The use of the contents, data and information provided in this datasheet is at the users' own risk.

Fujitsu has assembled this datasheet with care and will endeavor to keep the contents, data and information correct, accurate, comprehensive, complete and up to date.

Fujitsu Components Europe B.V. and affiliated companies do however not accept any responsibility or liability on their behalf, nor on behalf of its employees, for any loss or damage, direct, indirect or consequential, with respect to this datasheet, its contents, data, and information and related graphics and the correctness, reliability, accuracy, comprehensiveness, usefulness, availability and completeness thereof.

Nor do Fujitsu Components Europe B.V. and affiliated companies accept on their behalf, nor on behalf of its employees, any responsibility or liability for any representation or warrant of any kind, express or implied, including warranties of any kind for merchantability or fitness for particular use, with respect to these datasheets, its contents, data, information and related graphics and the correctness, reliability, accuracy, comprehensiveness, usefulness, availability and completeness thereof. Rev. March 02, 2011